

# P350 flexitrac™ system

90/UG080ENG/07 ISSUE 7 08/2014



## P350 flexitrax™ system user guide

**This user guide is intended for use with P350 Controller software versions 4.16 and above. For earlier software contact your local Pearpoint representative for older versions of the manual. The P350 flexitrax is a fully modular system; the command module can drive any combination of drums, cameras and crawlers and is also compatible with the P330+ and P340 flexiprobe™ range of pushrod reels and cameras.**

This user guide is intended as a compact version of the full operational manual for quick reference. A full operational manual is available on CD with your system purchase, online at [www.radiodetection.com](http://www.radiodetection.com) or contact your local Pearpoint representative for a copy. Full instructional and safety information on a variety of subjects is covered in the Operation Manual.

## Copyright statement

© 2014 Radiodetection Ltd. All rights reserved. Radiodetection is a subsidiary of SPX Corporation. SPX, the green ">" and "X" are trademarks of SPX Corporation, Inc. Radiodetection, Pearpoint, flexitrax, flexiprobe, FlexiSight and RD7000 are either trademarks of Radiodetection in the United States and/or other countries. Due to a policy of continued development, we reserve the right to alter or amend any published specification without notice.

This document may not be copied, reproduced, transmitted, modified or used, in whole or in part, without the prior written consent of Radiodetection Ltd.

The Bluetooth word, mark and logo are registered trademarks of Bluetooth SIG, Inc. and any use of such trademarks by Radiodetection is under license.

Windows, Windows XP, Windows Vista, Windows Explorer, Windows Media Player, Windows Movie Maker, Microsoft Word and Microsoft Office 97 are trademarks of Microsoft Corporation, all rights reserved.

Other trademarks or registered trademarks mentioned in this document belong to their respective owners.

Any third-party products (including hardware, software and services) mentioned in this manual are for instructional purposes only and is not an endorsement by Radiodetection Ltd, Pearpoint and SPX Corporation.

Radiodetection Ltd does not accept any liability for loss of data or damage to equipment when using any third-party products.

 **General warning symbol.**

 **Electrical hazard.**

 **Crush hazard exists.**

 **Heavy object. Take care when lifting and obey general manual handling precautions.**

 **Biohazards. Unsanitary conditions. Consider safety precautions and strict cleaning.**

 **Hot surface. Caution required during handling and around flammable/explosive substances.**

**WARNING! Red warnings alerts possible personal injury scenarios.**

**CAUTION: Orange cautions alert possible equipment damage.**

**NOTE: Blue notes contain useful information.**

## Safety

 **A risk assessment should be performed prior to commencing work as it may highlight additional safety issues specific to the application.**

 **The P350 flexitrax, including components, are heavy. If available, use the wheels to assist transport. Observe heavy-lifting safety practices when lifting any component of this system. Refer to the specifications in the Operation Manual Appendix for a description of the system dimensions and weight.**

**If mains operated equipment is connected to the system then the external equipment must be earthed in accordance with the manufacturer's instructions.**

 **Failure to comply with this may cause the unit to become live and a LETHAL HAZARD.**

 **The flexitrax Power Supply Unit (PSU) is designed to reduce hazards from electric shock provided that proper operating procedures are followed. The P350 flexitrax system requires connection to a protective earth. It is also recommended to use a residual current circuit breaker (RCCB) that can protect against electric shock. RCCB devices are known in some countries as Ground Fault Circuit Interruptors (GFCI). The RCCB needs to be suitable for a load of 13A and a tripping sensitivity of 30mA or less.**

 **Always carry out a risk assessment of the site to be inspected. This equipment is NOT approved for use in areas where hazardous, explosive or flammable gasses, liquids or solids may be present.**

 **Foul water systems can be a source of serious biological hazards. Wear appropriate protection when handling the P350 flexitrax.**

 **The camera will get hot during use. This is normal. Exercise care when handling the camera at all times.**

 **System components must NOT be connected/ disconnected when the power is on. When downhole equipment is not connected, turn off all power. Never touch live connectors, cable or system internal components without suitable electrically insulated gloves for high-voltages.**

 **The external connectors of the P350 Manual PSU unit and Powered Drum are required to be properly sealed by the blanking caps provided or by using the correct leads to prevent water damage to the units. Under no circumstances are these connectors to be left un-blanked.**

 **Care must be exercised when operating the drum that the hands, body and loose clothing are kept well clear of the cable entry area. The cable entry should not be used as a step and feet kept clear of this area.**

The controller display module has a waterproof seal flap protecting the I/O sockets – this must be closed in wet conditions to ensure it is rainproof. Do not use 3rd party USB memory drives, especially large USB memory drives that may prevent this waterproof door from closing – or you may incur water damage not covered by your warranty. Never clean your system with a pressure washer.

 On downhole equipment, a modified screw is used to ensure waterproof connections. It is critically important that only our official screws are used, our screws are modified to ensure waterproof and reliable connection. Significant damage and costs will occur if “off-the-shelf” screws are used.

Take care to ensure that video and power cables do not get entangled in the drum. Cables ties are recommended and will not impede system performance.

Always store the P350 flexitrax system in a clean and dry environment.

Ensure that standard safety precautions for working in hostile environments are followed.

Electrical equipment is factory tested for electrical safety. Routine inspection is recommended (and may be required by law) to maintain this level of protection. If you are unsure, contact your local safety authority for advice.

 The flexitrax Power Supply Unit has a number of ventilation slots around the casing that are designed to maximize air circulation and reduce heat. There is a potential fire risk if the build-up of heat is prevented from escaping. Under no circumstances are these ventilation slots to be covered or blocked.

If using a generator follow the manufacturer’s instructions on load connection and sequencing. In the absence of these instructions the following guidelines should be used:

- When starting the generator; ensure that all electrical loads, including the P350 are switched off before starting the generator. Allow the generator to stabilize before connecting any electrical loads or switching on the P350.
- When stopping the generator; ensure all electrical loads, including the P350 are switched off before stopping the generator.
- Starting or stopping a generator whilst the P350 system is connected and the main switch is in the On position could lead to damage to the P350 system or the generator.

 Always use heavy duty industrial gloves when handling cable which is being withdrawn from a sewer.

Always ensure that cabling is properly connected.

 A portable generator can be a hazard if not properly operated. Always follow the manufacturer’s instructions.

 Always transport a generator with the minimum amount of fuel in the tank.

Always switch the system on and off using the main system switch.

 Never lower crawlers or other heavy equipment into manholes while personnel work in the manhole.

 To avoid risk of burns do not touch cameras or lighthoods when they are switched on or immediately after switch off. Leave ample time for them to cool before handling.

 The camera’s LEDs are very powerful. Do not look directly at the LEDs or point them at other people.

Caution must be taken when conducting any pipeline or draining system inspection. Please observe all safety warnings located in the Preface and throughout this operation manual.

Before you attempt to operate the P350 flexitrax system, it is recommended that you familiarize yourself with any additional health and safety requirements that may be defined by company policy and any applicable local or national laws. Contact your company’s or local government’s health and safety officer for further information. Any depth estimation information resolved using the Sonde features should be considered a guide only, we cannot be held liable for inaccurate locate data.

It is recommended that an Residual Current Circuit Breaker is used with the P350 system. Such a circuit breaker may be incorporated into the supply such as at a generator panel or a standalone unit.

There are no user serviceable components on the P350 system. This may void the product warranty.

An inverter-style generator is necessary to power this system, see the operation manual for full details on suitable generators and power requirements.

## Section 1 – System overview

The P350 flexitrax is a modular system that is compatible with a variety of powered, manual drums and pushrod reels. The flexitrax command module can drive any combination of drums, crawlers and cameras and is compatible with the range of P340 flexiprobe pushrod reels and cameras. The modularity of the system allows you to create your own solution for a wide range of deployment scenarios.

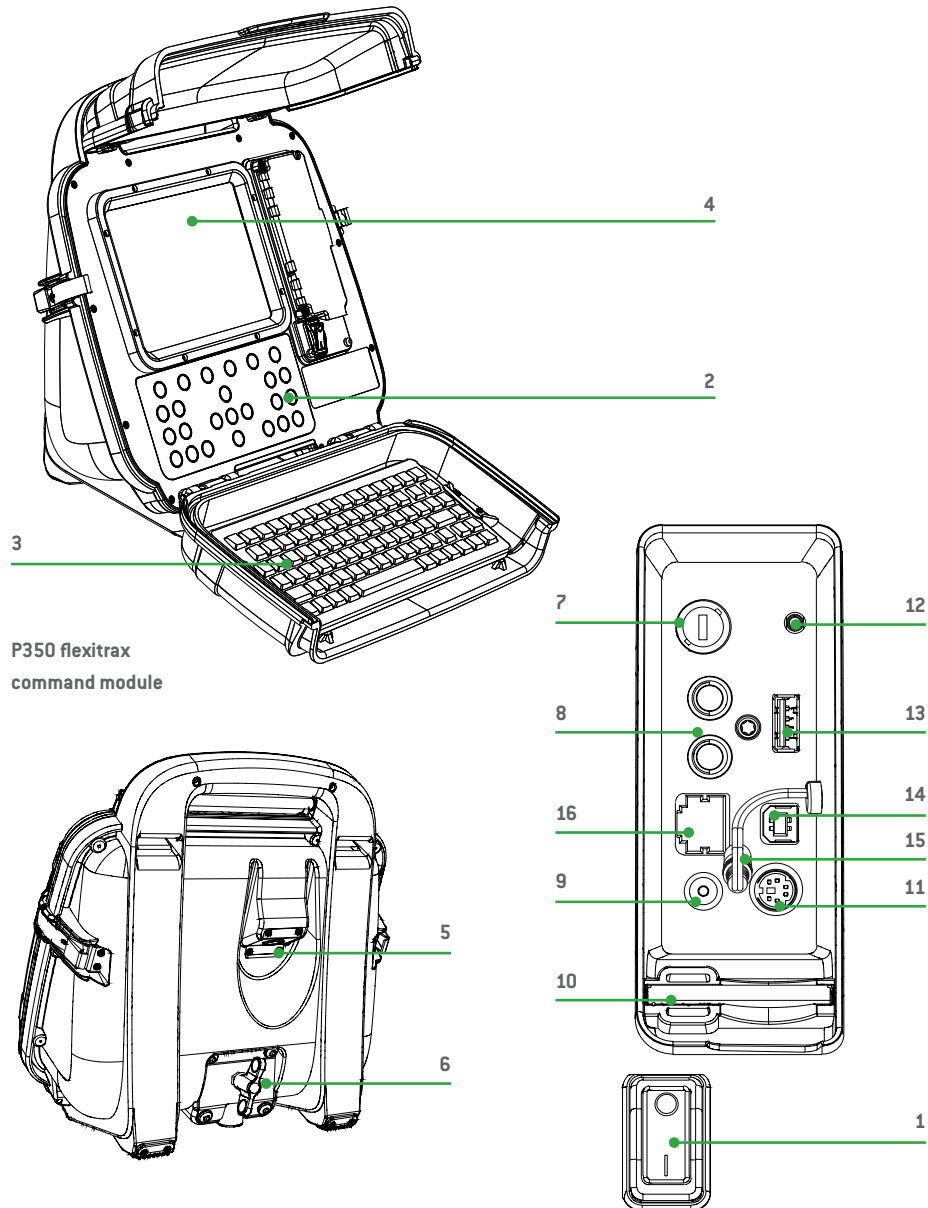

P350 flexitrax  
command module

### 1.1 Command module

The command module acts as the controller and digital video recorder and playback device. Video is displayed on an 8" industrial LCD. Video, pictures and inspection reports are stored on a compatible high-speed memory card.

1. On/Off Switch. This switch only works when the unit is powered by a DC source connected to the power socket.
2. Keypad and function keys: Allows the operator to control the system, select functions and edit text entries.
3. Keyboard: Provides enhanced text entry capabilities and shortcuts to access system functions.
4. Display: LCD Screen shows video, images and various on-screen system information.
5. Link Cable Socket: Connects to a pushrod reel, powered drum or manual external PSU.
6. Command Module support clamp: Mount the command module onto the Drum support bracket or to the optional vehicle wall-mounting kit.
7. Fuse holder: 5 x 20mm T3.15A 250V cartridge fuse.
8. RCA Video Jacks: Provide secondary input and output options for external composite video equipment.
9. Power Socket: DC power input from vehicle supply, battery options or mains adapter. For use with pushrod reels or as a standalone unit.
10. Compact Flash card slot: The command module uses a Compact Flash card to store video recordings, reports and pictures. Most stored files can be viewed or played on the command module or transferred to PC. Also used to store and upload firmware upgrades.
11. Keyboard Socket: Connects the keyboard.
12. Audio Socket: Connects the optional headset to record audio over videos.
13. USB-A socket: USB Memory card slot for recording video, pictures, report information. Can also be used to store and upload firmware upgrades. Compatible cards only. Unauthorized USB memory drives also suffer from poor video recording and potential system crashes, so always buy these from Pearpoint – and may prevent the rainproof door from fully closing.
14. USB-B Socket: USB connection to transfer files to computers.
15. (Optional) Internal battery lead, this dual-use cable is used to charge the internal battery, or plugs into item 9, to power the controller when the battery is charged.
16. Ethernet RJ-45 socket: Connects to a PC running compatible reporting software.
17. Optional Vehicle wall mount kit: to mount the command module to the side of your van (not shown).

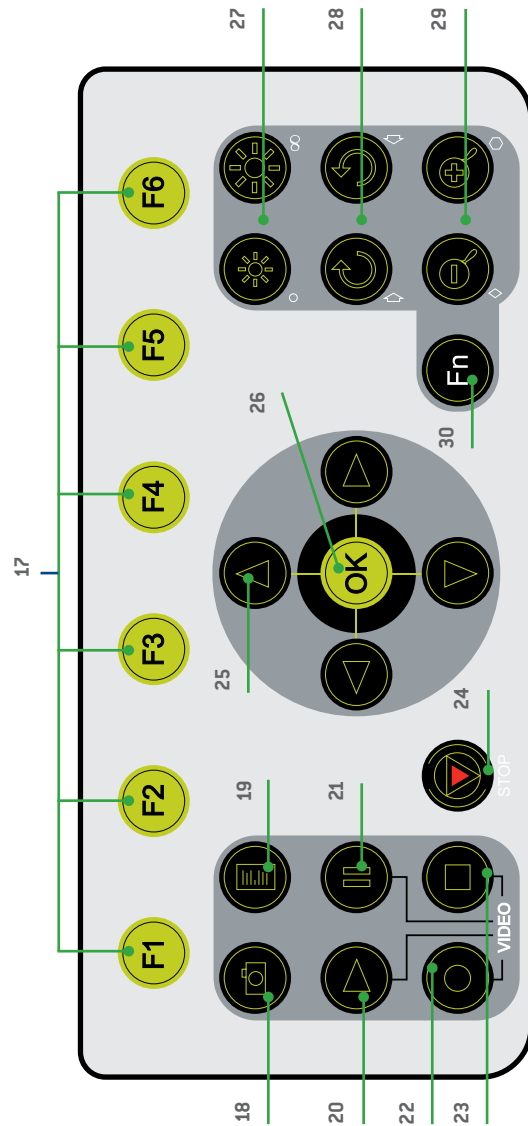

### 1.1.1 Keypad

17. Function keys: Use to select menu items or activate short cuts.
18. Camera key: Press to take screen captures.
19. Text key: Press to access the on-screen text writer menu.
20. Play: Enters the card browser menu. Starts video playback of selected file.
21. Pause: Press to pause video playback or recording.
22. Record: Press to begin a new video recording.
23. Stop: Press to stop video playback or recording.
24. Crawler stop: Stops the crawler moving.
25. Arrow keys: Use for navigation and to select system parameters.
26. OK: Press to select or confirm choices in the menu system.
27. LED Brightness/Camera Focus keys: press to adjust LED brightness. **Fn + Brightness** to adjust camera focus.
28. Rotate/Pan keys: press to rotate the camera view. **Fn + Rotate** to pan left or right. Simultaneous press will recenter the view.
29. Zoom/Iris – AGC keys: press to zoom in or out of the camera's subject. **Fn + Zoom** to modify the Iris and Automatic Gain Control settings (AGC not available on Pan and Tilt Zoom camera). Simultaneous press will reset the zoom, **Fn + simultaneous press** will reset to automatic iris and disable the AGC.
30. Function key: Use in combination with other keys to activate secondary button functions. Pressing and holding just the Function Key does nothing.

Powered drum with command module installed

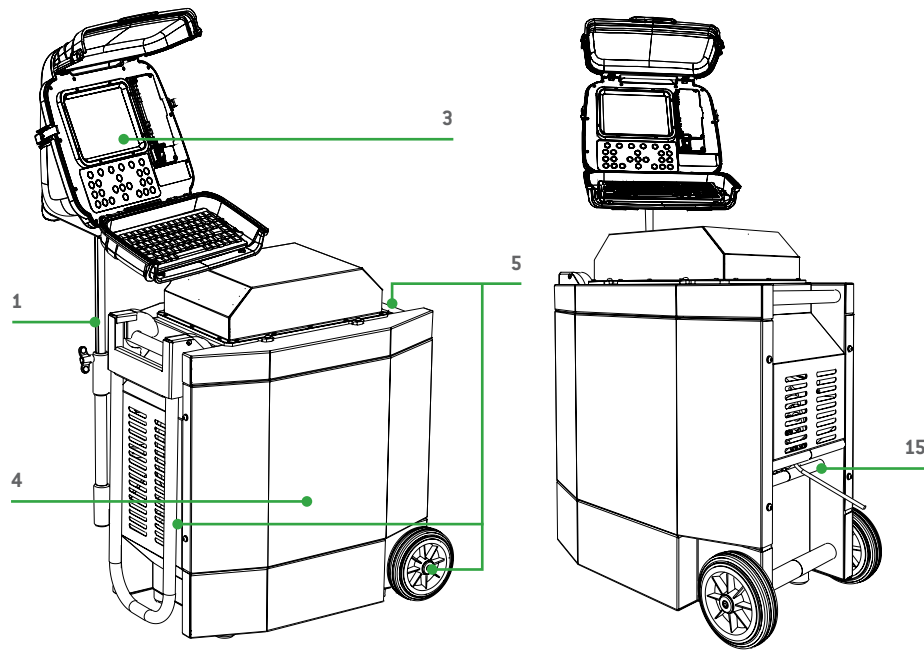

Front and rear connection panels (Common to powered drum and external PSU)

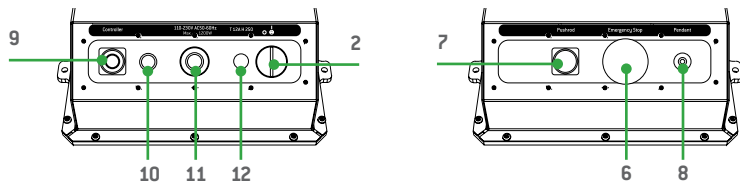

Manual drum

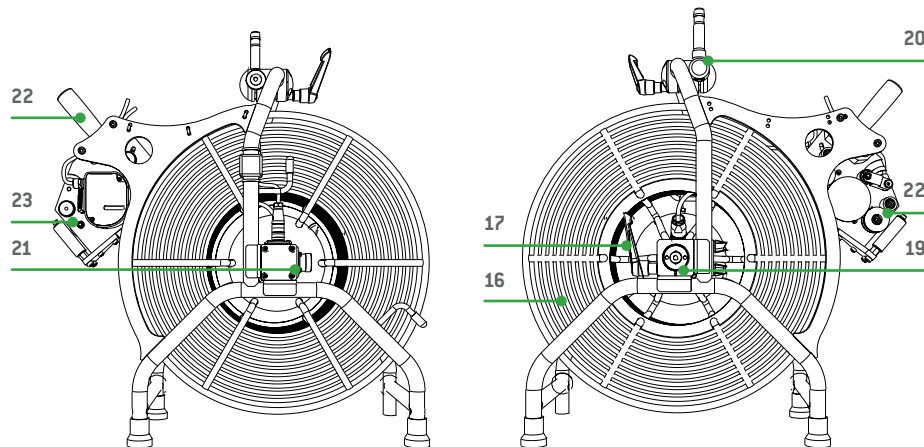

## 1.2 Cable Drums

The system supports either a powered or manual drum that can accommodate cable lengths between 100-305m (330-1000'). The powered drum contains an integral power supply whilst the manual drum requires an external power supply unit. Please refer to the Operation Manual for more information.

### 1.2.1 Powered drum

1. Command module support stand.
2. On/Off switch. Switches the system on or off.
3. Command module.
4. Reel compartment: Houses up to 305m (1000') of cable wound onto the drum cassette.
5. Handle bars, wheels and removable handles: Allow you to manoeuvre the system easily into position.
6. Emergency stop: Instantly shuts off system power. When initiated, the system must be reset.
7. Pushrod connector: Connect and power compatible P340 pushrod systems to your P350 controller.
8. Pendant Controller connector, for joystick/button control of system.
9. Command module connector: To connect the command module link cable.

14. Optional vehicle mounting rails: Secures the motorized drum in your van. (Not shown).

15. Cable rollers.

### 1.2.2 Manual drum

16. Cable drum: Houses up to 305m (1000') of cable.
17. Cable brake.
18. Crawler connection terminal (Not shown).
19. Crank handle socket.
20. Command module support clamp.
21. PSU link cable socket.
22. Manual layering handle: To assist with laying cable evenly on the drum.
23. Cable rollers.

### 1.2.3 External PSU (manual system only)

24. Link cable connection for manual drum.

10. Power on/off indicator. A White LED lights up when the PSU is switched on and powered up.
11. Power supply socket: To connect mains power.
12. Fuse holder: 5 x 20mm T12A 250V cartridge fuse.
13. Crank handle: Will allow the manual retrieval of the deployed cable. (Not shown).

External PSU

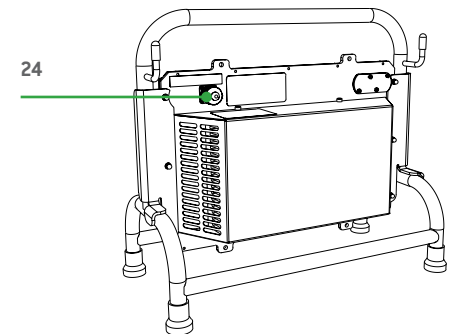

### 1.2.4 Link cables

25. Command module link cable.

26. Manual drum link cable.

Link cables



### 1.3 Crawlers and Crawler cameras

The system is compatible with the P354 and P356 crawlers. Both the P354 and P356 crawlers are fully compatible with three interchangeable cameras. The P350-CAM-FW is a fixed, forward view camera. The P350-CAM-PT offers pan and tilt capabilities and the P350-CAM-PTZ offers pan, tilt and 10x optical zoom.

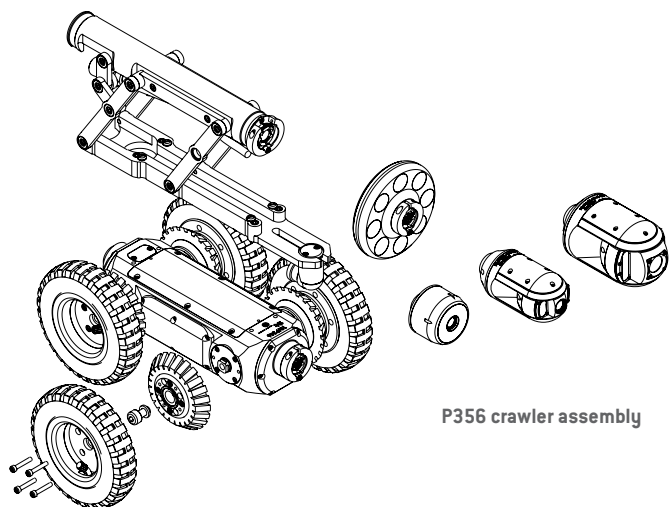

P356 crawler assembly

### 1.4 Pushrod reels and cameras

The P350 command module is compatible with the P340 range of pushrod cameras. Which can be plugged directly into the controller or plugged into the drum PSU. An adaptor cable is required to plug pushrod systems directly into a P350.

### 1.5 Other accessories

The P350 flexitrac system features a range of accessories that expand its functionality and range of applications. Please refer to the P350 flexitrac Operation Manual, for a description of available accessories. Also visit [www.radiodetection.com](http://www.radiodetection.com) for a complete list of available accessories.

Cable deployment rollers

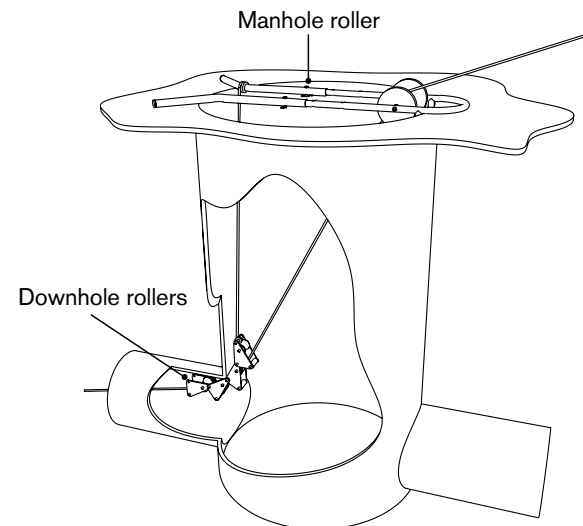

Crawler grab kit

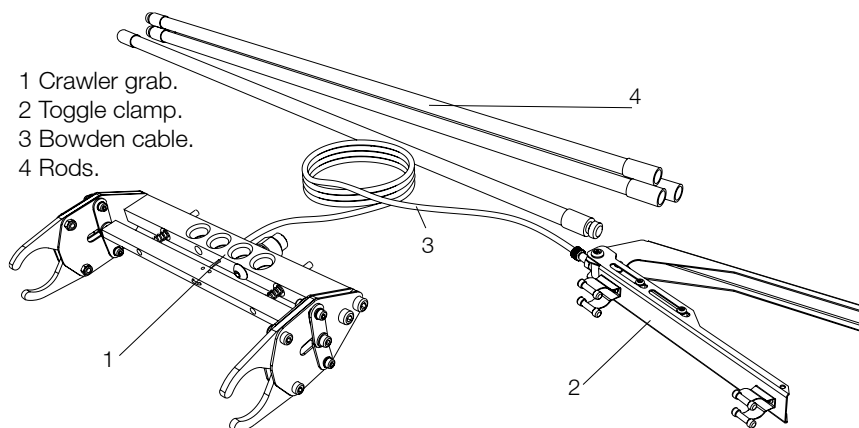



Wheel and elevator configurations

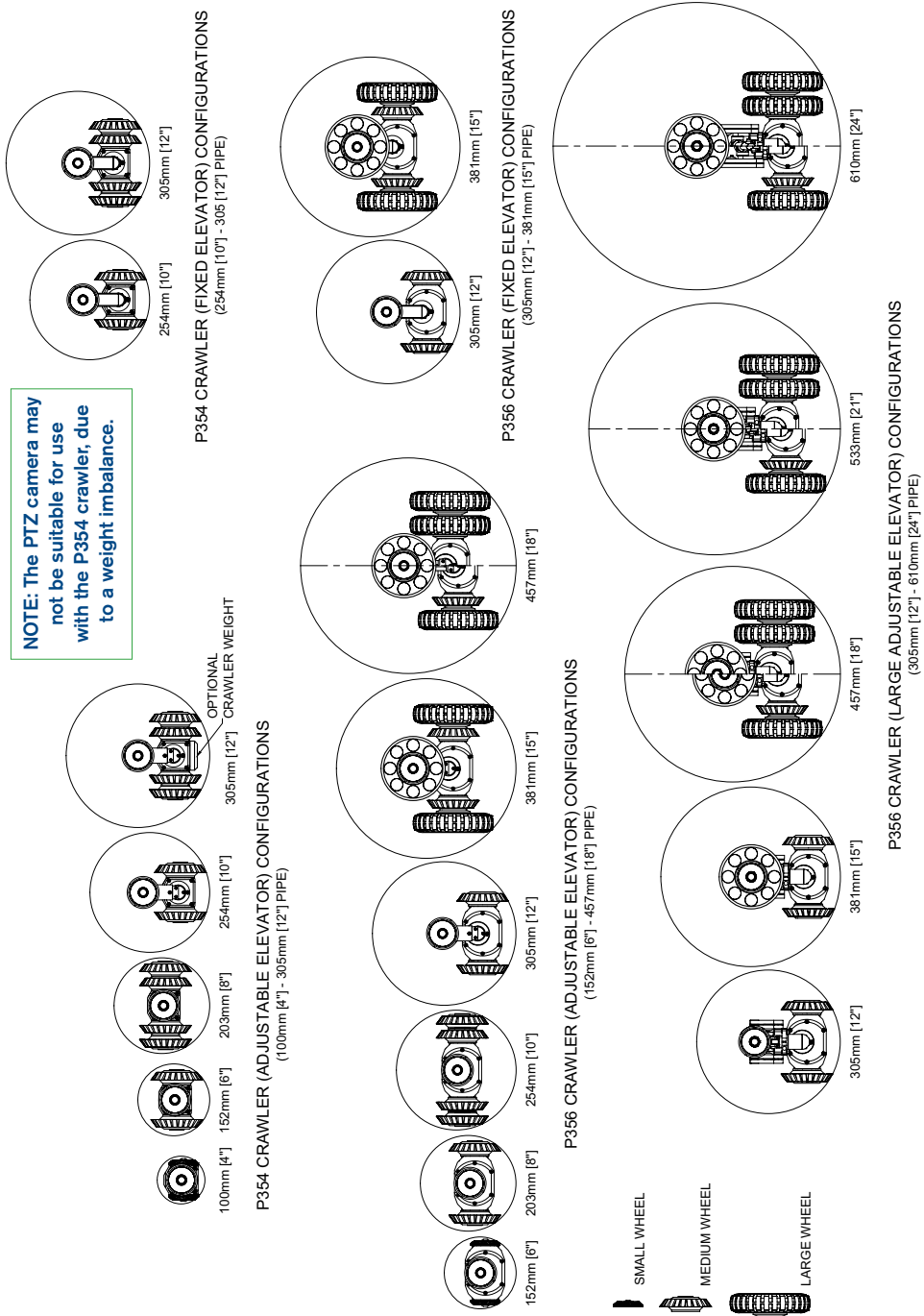

Crawler Rasp Wheel configurations

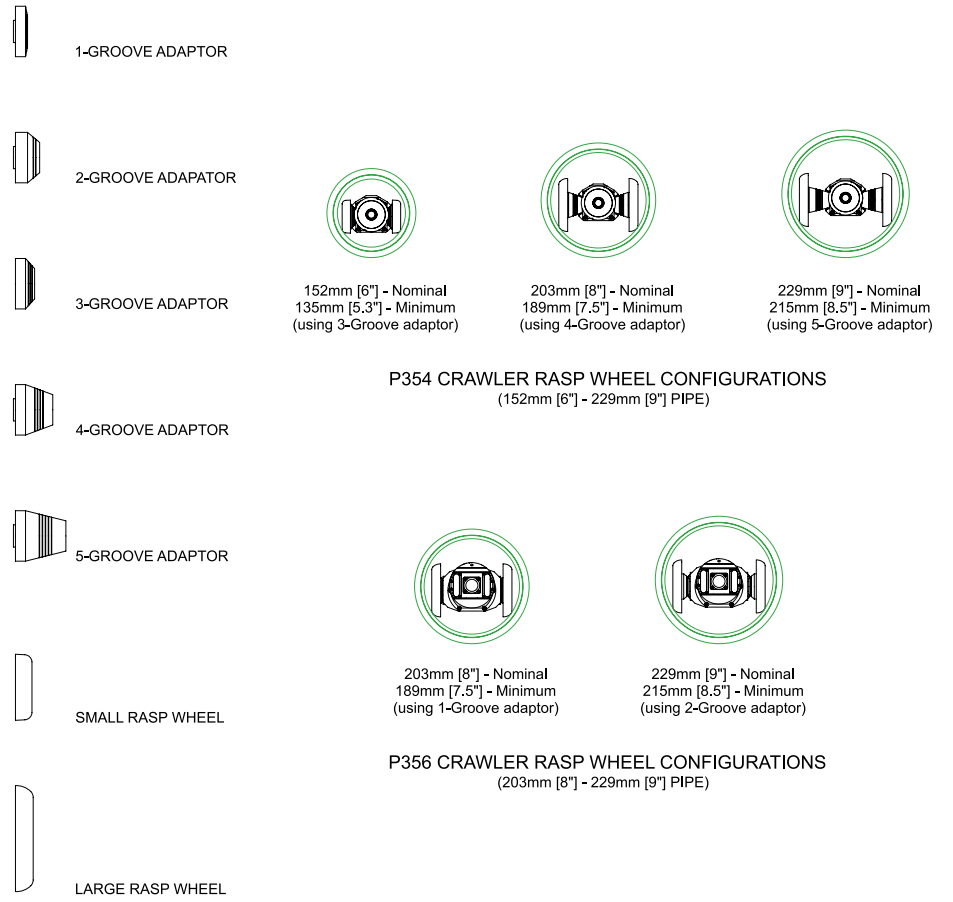

## Section 2 – Setup

The P350 flexitrac allows you to configure the system in a number of ways, depending on which components you have purchased. This section provides an overview of the setup procedure using the Powered and Manual Drums. For pushrod instructions, please refer to the P340 flexiprobe Operation Manual.

**⚠ CAUTION! Before attempting to assemble the system, ensure that the Powered Drum or the Manual PSU are switched off.**

### 2.1 Assembly

#### 2.1.1 Crawler

You can configure the crawlers with a variety of wheels, cameras and elevators to suit a wide range of pipes.

#### Wheels

The P354 is compatible with the 62mm (2.5") and 110mm (4.3") wheel sets, which can be connected in singular or tandem configurations for deployment in pipes from 100mm (4")\* up to 380mm (15") in diameter.

The P356 is compatible with the 62mm (2.5"), 110mm (4.3") and 170mm (6.7") wheels, which can be connected in singular or tandem configurations for deployment in pipes from 150mm (6") to 610mm (24") in diameter.

A range of specialist wheels are available for advanced users, for instance with slimmer profiles, gritty abrasive wheels for greasy relined pipes and doubled-up configurations for additional traction.

Abrasive wheel kits are available for both crawlers, in kits suitable for 6" to 9" pipes (150mm-225mm). These can give enhanced grip in challenging pipe conditions, such as greasy or re-lined pipes.

**NOTE: Make sure you affix the wheel screws firmly to the crawler body.**

\*Minimum specified pipe diameter must be maintained along the whole length of the survey.

#### Cameras

The cameras are simple to attach as they can only be fitted in one way. A single Allen-head bolt is used to secure the camera's collar to the crawler's body.

#### Elevator

The elevator is used to elevate the camera to help center it in the pipe or conduit you wish to survey. The elevator is installed between the crawler and camera. The crawlers are compatible with three elevators:

- **Fixed elevator.** To deploy the P354 in pipes up to 305mm (12") and the P356 in pipes up to 381mm (15").

- **Adjustable elevator.** To deploy the P354 in pipes up to 381mm (15") and the P356 in pipes up to 457mm (18").
- **Large adjustable elevator (P356 only).** To deploy the P356 in pipes from 305mm to 610mm (12 to 24").

#### Lighthouse

The accessory lighthouse provides the camera with more light. With more light you can deploy the crawler in larger pipes or in pipes made from absorbent material that would otherwise reduce visibility when inspected with the standard camera's LEDs.

The lighthouse is fitted between the camera and the crawler or between the camera and the elevator.

Once you have assembled the crawler, connect it to the cable using the termination socket at the rear of the crawler's body.

### 2.2 Manual Drum and External PSU

The Manual Drum is a light-weight system that can house up to 305m (1000') of cable. The Manual PSU connects to the Manual Drum using the link cable.

### 2.3 Powered Drum

The Powered Drum features a motorized cable reel compartment that can house up to 305m (1000') of cable.

**⚠ CAUTION! If you are manually pulling out cable from the powered drum, take care not to exceed the maximum speed of the crawlers (25.3m x minute) otherwise some damage may result.**

### 2.4 Pendant controller

The P350 pendant controller is an optional accessory which allows you to control system functions.

The pendant controller connects to the rear panel on the powered drum or manual PSU.

For detailed instructions on how to use the pendant controller, please refer to the Operation manual.

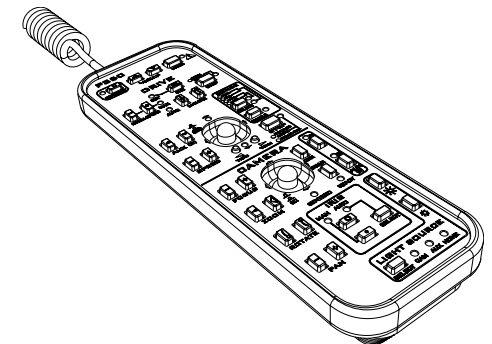

## 2.5 Command module

### 2.5.1 Mounting

You can mount the command module to the powered drum using the support stand. The stand is fitted to the drum chassis and the command module fits on top. Once fitted to the drum, you can adjust the height of the command module to suit your preferences of working environment.

If using a manual drum you can mount the command module to the support stand, which is clamped to the drum carrying handle.

### 2.5.2 Power, data and video

When using the Manual or Powered Drum, a single link cable supplies the command module with power, data and video. The link cable socket is located on the rear side of the command module.

Mount the command module and connect the link cable to the controller terminal on the Powered Drum or External PSU.

If using the command module with a pushrod system or as a standalone unit, you must connect the command module to a suitable DC source using the power socket located on the front connection panel.

## 2.6 Starting the system

When the system is correctly assembled, switch it on using the On/Off switch on the Powered Drum or External PSU.

If you are using a pushrod system or the command module as a standalone unit, use the On/Off switch on the command module's I/O panel.

The command module will display a welcome screen with important information. Note it and press OK to continue.

**NOTE: When you power off the system, wait at least 5 seconds before switching it on again. Failure to do so may cause the command module to lock up.**

## 2.7 On-screen menu

You can interact with the command module using the intuitive on-screen menu.

To navigate the menus use the function and arrow keys. The ◀ key is used to return to the previous screen. Where a selection is required use the ▲ or ▼ keys to select the various options. Use the OK key to confirm the selected choice and return to the previous menu. You can also use the keyboard's Function, ESC, Enter and cursor keys to navigate and select options in the menu

For a complete description of the menu system, please refer to the Operation Manual.

## 2.8 Getting help

The command module has a built in, context sensitive help screen. To access the help page press **Fn + F1** simultaneously on the keypad or **Shift + F1** on the keyboard.

You can also view a list of shortcuts. Shortcuts help make operation of the system more efficient by saving you time. To see a list of shortcuts press **Fn + F2** simultaneously or press **Shift + F2** on the keyboard.

For more detailed instructions, please read the Operation Manual.

## 2.9 Configuration

### 2.9.1 First use

When first using the system, be sure to set or check the following settings:

**NOTE: The system will store your preferences, cable length and wheels when it is switched off. If you reset the system to factory default, these settings are lost. To perform a factory reset, please refer to the Operation Manual.**

#### Date and time

If required, enter the correct date and time and choose your preferred format. Setting this is important as it is used to time stamp video recordings and other important files.

Go to **MENU->SETUP->CONTROLLER->BASIC SETTINGS->** Select **TIME** or **DATE**.

#### Units of measurement

The P350 system supports metric and imperial (US customary) units.

To select your preferred unit of measurement system, go to **MENU->SETUP->CONTROLLER->BASIC SETTINGS->COUNTER UNITS** and select **METRIC** or **IMPERIAL**.

#### Language

The system supports several languages.

To set your preferred language, go to **MENU->SETUP->CONTROLLER->BASIC SETTINGS->LANGUAGES**.

#### Cable length and drum type

Setting the correct cable length is important to help improve video quality and calculate crawler and drum speeds. You must check this setting, and change if required, every time you replace or change the cable reel or switch between pushrod and crawler-based configurations. You will cause damage to your system if you select the wrong size of drum/reel/wheels.

To set the cable length and drum type, go to **MENU->SETUP->EQUIPMENT->** select **REEL** and scroll to your drum. You may also select **EQ ADJUST** which may improve image quality.

**NOTE:** If set as a pushrod system, the P350 command module will fail to work with the crawler system.

### Crawler wheel size

You must specify the size of the currently installed wheels as the system uses this information to calculate the crawler's speed.

**⚠ CAUTION!** Incorrectly setting the wheel size may compromise the retrieval process and result in jamming the crawler's wheel on the cable.

To set the wheel size, go to **MENU->SETUP->EQUIPMENT->WHEELS**.

### Numeric inclinometer

The crawler features an integrated precision inclinometer that provides a real time numeric reading of the crawler's body inclination.

The P350 inclinometer supports two units of measurement: Degrees or Gradients. You should calibrate the numeric pitch before starting a survey, with the crawler in its final setup (wheels, elevator and elevator height set).

To calibrate the inclinometer, go to **MENU->SETUP->MAINTENANCE->CALIBRATE TRACTOR NUMERIC PITCH** and follow the instructions.

Uneven/worn/uncalibrated wheels may be factors which reduce the accuracy of the inclinometer or pipe profile mapping.

To turn the inclinometer on or off, go to **MENU->SETUP->ON-SCREEN INFORMATION->PITCH** and select **ON** or **OFF**.

To change the inclinometer units, go to **MENU->SETUP->BASIC SETTINGS-PITCH UNITS** and select **Degrees** or **Gradients**.

This can be used with our companion software FlexiSight Manager (optional paid profiling module) to survey and map the profile of the pipe.

### OSD layouts

The P350 System offers a choice of 3 different layouts for the position of Date, Time, Counter and Pitch; these layouts are: normal, TV and custom.

To choose a layout or to customize the position or visibility of the OSD information fields go to the Layout menu: **MENU->SETUP-ON-SCREEN INFORMATION**. Select **SCHEME** to enter the OSD layout menu.

1. Use the  $\triangle$  and  $\nabla$  keys to select your desired layout.
2. Press OK to confirm your choice and return to the Layout menu.

**Normal layout:** This is the standard layout optimised to make use of the entire screen.

**Custom Layout:** This layout is customisable. The position of the 4 OSD information fields can be moved anywhere on the screen.

**TV layout:** This layout is optimised for a DVD Recorder/TV screen. Refer to the Operational Manual for more information.

## Section 3 – Deploying the crawler

Once the system is correctly installed, you can deploy the crawler in the pipe or conduit you wish to survey. Care must be taken when deploying the crawler, particularly if it is being deployed in deep conduits and cisterns.

**⚠ CAUTION!** Do not attempt to lift the crawler by the cable. Do not drop the crawler as it may damage the camera and the system's electronics.

**⚠ WARNING:** The crawlers are heavy! Observe proper lifting procedures when handling, deploying and retrieving the crawler. Never lower tractors or other heavy equipment into manholes while personnel are working in the manhole.

### 3.1 Crawler deployment tool

The crawler deployment grab tools for the P354 and P356 crawlers are optional accessories that allow an operator to safely deploy and retrieve a crawler into manholes, culverts and other access points. The grab tool can deploy and retrieve the crawler in conduits up to five meters (16.5 feet) deep. Using the crawler grab tool is highly recommended.

Refer to the Operation Manual for a detailed guide on how to setup and use the crawler deployment tools.

### 3.2 Cable deployment rollers

The optional cable deployment rollers help protect the cable from scoring on concrete and other abrasive materials. Pearpoint recommends that you always use cable deployment rollers.

### 3.3 Distance counter and Auto Stop point

Once you have deployed and positioned the crawler in the manhole you should zero the distance counter, press F10 on the keyboard to zero the counter.

The zero (0.0) position is used by the powered system to decide when to stop reversing or retrieving the crawler. You can also set a different stop point called **Auto Stop**. The system will stop reversing when this stop point is reached.

#### To set this limit:

Move the crawler to desired counter position, go to:

**MENU > SETUP > EQUIPMENT >** and choose **AUTO-STOP**.

Please note that the Auto Stop position is saved by the system and will be active until it is reset.

#### To reset the Auto Stop point:

Zero the counter and set this to become the new Auto Stop limit.

### 3.4 Activating the sonde

The crawler features an integrated, multi-frequency sonde. This allows you to locate the crawler's position using a Radiodetection cable and pipe locator.



To activate the sonde press **Fn + F5** on the keypad or **shift + F5** on the keyboard.

Refer to the Operation Manual for instructions on how to vary the transmitting frequency.

## Section 4 – Camera controls

The P350 cameras have a range of features to help you locate faults in more demanding conditions.

### 4.1 Lights

All cameras feature LED floodlights to help illuminate pipes and conduits. LED brightness is controlled using the brightness controls on the keypad. Press  to reduce or  to increase brightness.

If no auxiliary lighthouse is used, press the brightness keys simultaneously to toggle the lights off or switch them on to their previous level.

#### 4.1.1 Auxiliary lighthouse

The camera's LEDs and the auxiliary lighthouse can be operated simultaneously or independently. If a lighthouse is connected, simultaneously pressing the brightness keys will toggle the light controls between the following modes:

- Light control: ALL. Adjust both the camera and lighthouse in series.
- Light Control: AUX. Adjust the lighthouse only.
- Light control: CAMERA. Adjust the camera only.



When selected, the light control mode will flash on-screen and fade. Use the brightness keys to adjust the lighting level.





**NOTE: When a lighthouse is connected you cannot toggle the lights on and off using a simultaneous press of the brightness keys as this will change the control mode. To switch off the lights when a lighthouse is connected, press the button until the lights are switched off.**

**⚠ WARNING! The camera and lighthouse LEDs are very powerful. Do not look directly at the LEDs or point them at other people.**

### 4.2 Focus

You can manually adjust the focus of P350 cameras.



To focus in or out of the FW and PT camera's subject, press **Fn key and  or .**

The P350-CAM-PTZ camera features automatic focus. You can adjust the focus manually using the **Fn and  or .** To resume automatic focus mode press **Fn,  and ** simultaneously.

**NOTE: the P350-CAM-FW and P350-CAM-PT have a focus range of 10mm (1/2") to infinity. The P350-CAM-PTZ has a focus range of 10mm (1/2") (WIDE) to infinity.**

### 4.3 Pan

When using the P350-CAM-FW camera you can use the pan function to digitally pan a zoomed-in picture on screen.

To pan left or right, press **Fn and  or ** once to pan a fixed step in that direction.



Press simultaneously **Fn,  and ** to reset the digital pan.

When using the P350-CAM-PT and P350-CAM-PTZ cameras you can pan from side to side, giving a wide field of vision without having to manoeuvre the whole crawler.

To pan left or right, press **Fn and  or ** once to start panning in that direction. Press either key again to stop the camera panning.

### 4.4 Tilt or rotate

When using the P350-CAM-FW camera you can use the rotate function to digitally rotate the picture on screen.

Press  or  once to digitally rotate of a fixed step the picture clockwise or anti-clockwise.

Press simultaneously  and  to reset the digital rotation.



The P350-CAM-PT and P350-CAM-PTZ cameras can rotate. When combined with the pan function, you can survey objects above and below the crawler.

To start to tilt/rotate the video on-screen clockwise press .

To start to tilt/rotate the video on-screen anti-clockwise press .

To stop rotating press either key again.

## 4.5 Center

When using the P350-CAM-PT and P350-CAM-PTZ you can return the camera to the forward view, leveled position, by pressing  and  simultaneously.



## 4.6 Zoom

The P350 system offers digital zoom capabilities when used with the P350-CAM-FW and P350-Cam-PT.

The P350-CAM-PTZ camera features a 10x optical zoom. The digital zoom is disabled when this camera is used.

To zoom in on the camera's subject press .

To zoom out from the camera's subject press .

To reset the zoom to x1 magnification press  and  simultaneously.

## 4.7 IRIS/AGC

On occasion, there may be a requirement for manual control of the iris to change the picture brightness (e.g. to reduce a reflective glint from a shiny surface). Manually opening the iris to maximum aperture will allow more light to enter the camera giving a brighter picture. Closing the iris to the minimum aperture will decrease the amount of light entering the camera giving a darker picture.

Forward view and pan and tilt (with software version 2.25 or later) cameras offer Automatic Gain Control (AGC), which once activated allows cameras to be used in poorer light conditions.

Press the  key to increase the picture brightness or to enable the AGC, once the widest iris setting has been reached (forward view and pan and tilt camera only).

Press the  key to reduce the picture brightness.

# Section 5 – Driving the crawler

This section provides instructions for driving and retrieving the P350 crawlers when used with the manual or powered drum. Although the principle is the same, the powered drum offers several automated features that make it easy to retrieve the crawler automatically.

 **CAUTION! Make sure you have set the correct wheel size before you attempt to drive the crawler.**

## 5.1 Emergency stop

The Emergency Stop button located on the PSU will completely shut down the command module and all system components when pressed. As a fail-safe, the system must be reset before you can switch on the system again. Do not reset the system until it is safe to do so. To reset the system ensure the power is switched off at the main switch (item 2 on page 6), rotate the Emergency Stop button clockwise and then switch the power back on.

**NOTE: Initiating an Emergency Stop may result in loss of data on the memory card, particularly if a recording or playback was in progress.**

## 5.2 System stop

You can stop the drive system, including the crawler and the powered drum at any time by pressing the **Ctrl + C**, or .

When controlling the system from the keyboard you can also use the spacebar to stop the system.

When stopped, the crawler will be in Brake mode. Press the spacebar, **Ctrl + C**, or  to toggle the Brake.

 **WARNING! System stop is not a substitute for making an Emergency Stop. If there is any emergency use the Emergency Stop button located on the PSU. Please refer to Section 5.1 for more information.**

## 5.3 Driving and the On-screen display

**NOTE: If you have selected a Pushrod, ROD will be displayed by the OSD.**

The command module's onscreen display (OSD) will provide you with critical information, navigation and telemetry assistance as well as pan and tilt camera controls (if available) using mimic.

The driving OSD includes the following information:

- Mode.
- Status.
- Time.
- Date.
- DVR status.
- Distance counter.
- Page.
- Numeric inclinometer.
- Mimic.

Some information displayed on this screen can be hidden or moved. Refer to the operational manual for more information.

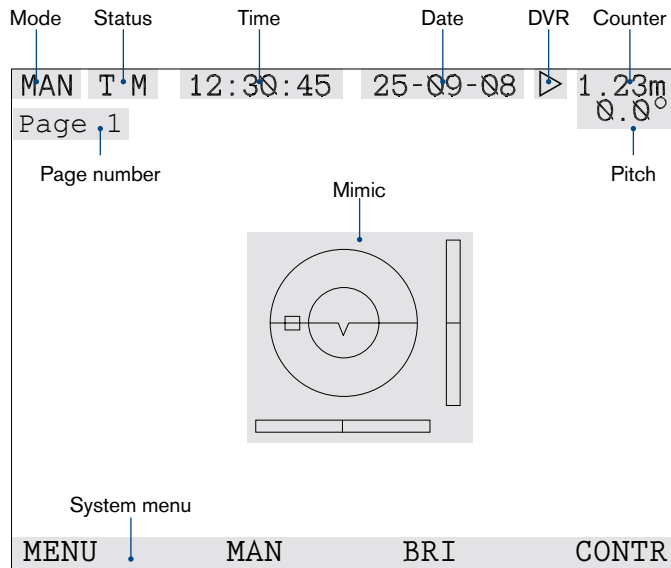

Driving mode OSD

## 5.4 Mimic

Mimic is an intuitive on-screen feature that helps you control the movements of the crawler and the position of the camera's viewing angle (PT and PTZ cameras only).

### 5.4.1 Basic mimic

The basic mimic display appears when a P354 crawler is connected to the system. Basic mimic features an artificial horizon and a speed indicator that shows the crawler's forward and reverse speed.

### 5.4.2 Steering mimic

Steering mimic is displayed when a P356 crawler is connected to the system. In addition to the features of the basic mimic, steering mimic features a steering bar that indicates when the crawler is turning, steering left or right and the speed at which it is moving.

### 5.4.3 Pan and tilt camera mimic

Pan and tilt camera mimic is displayed when a pan and tilt camera is connected to the system. Pan and tilt camera mimic provides a two dimensional representation of a pan and tilt camera's three dimensional range of movements. The mimic cursor, represented by the square box, acts as a target, which can be positioned using the following keys on the keyboard:

- **W** (up).
- **A** (left).
- **S** (go to).
- **D** (right).
- **X** (down).

Once you have positioned the cursor on the desired position, press the S key and the camera will automatically move itself to look at the target.

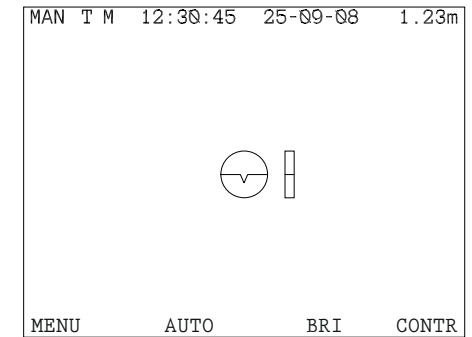

Basic mimic

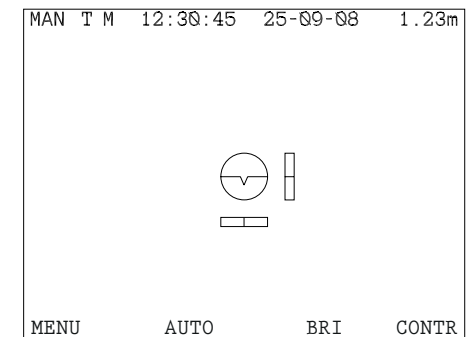

Steering mimic

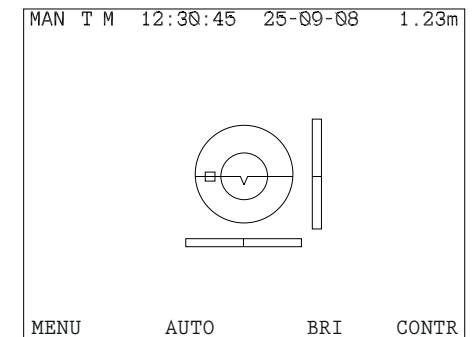

Pan and tilt mimic with steering bar

## 5.5 Manual system

### Moving forward

**NOTE:** There is no difference in operation between the Manual or Automatic mode when moving the crawler forwards.

Press  $\triangle$  to move the crawler forward. Increase the speed by holding or pressing  $\triangle$ . Decrease the speed by holding or pressing  $\nabla$ .

**NOTE:** If you continue to press  $\nabla$  when the crawler has stopped, it will move in reverse. The crawler will automatically stop when the cable counter reaches 0.0.

### Reversing

**⚠ CAUTION!** When reversing or retrieving the crawler ensure that the cable is retrieved at the same or higher speed than the crawler. Failure to do so may cause the crawler to get tangled in the cable and stall.

Use the crank handle to retrieve the cable. Use the manual wind layering handle to ensure the cable is laid evenly in the drum.

You can reverse the crawler in Manual (**MAN**) or Automatic (**AUT**). Press **F3** to toggle between Automatic and Manual driving modes.

### Manual mode

In **MAN** mode, the crawler will start moving backwards as soon as it is driven. Press  $\nabla$  to reverse the crawler. Increase the speed by holding or pressing  $\nabla$ . Decrease the speed by holding or pressing  $\triangle$ .

### Automatic mode

In **AUT** mode the crawler will not move backwards until it detects that the cable is being retrieved. Automatic mode is recommended for most situations.

To enable the crawler ensure to be in Automatic mode and press  $\nabla$  once.

**NOTE:** The mimic speed bar is disabled in automatic mode. The crawler's speed is automatically set to match the retrieval speed of the cable.

The crawler will stop moving if the cable is no longer retrieved.

## 5.6 Powered drum

### Moving forward

**NOTE:** There is no difference in operation between the Manual or Automatic mode when moving the crawler forwards.

Press  $\triangle$  to move the crawler forward. Increase the speed by holding or pressing  $\triangle$ . Decrease the speed by holding or pressing  $\nabla$ .

**NOTE:** If you continue to press  $\nabla$  when the crawler has stopped, it will move in reverse.

### Reversing

**NOTE:** The crawler will automatically stop when the cable counter reaches 0.0, or when the auto-stop position is reached. However, the crawler's momentum may cause it to roll a short distance beyond the 0.0 position. Please allow for this when you deploy the camera and zero the distance counter.

The powered drum supports two driving modes: Automatic and Manual. The main difference is that when reversing in manual mode, the crawler and powered drum operate independently. Manual driving gives you more control over the crawler and drum but can increase the risk of jamming the crawler wheels on the cable, particularly if the crawler reverses over the cable. Press **F3** to toggle between **AUT** and **MAN** driving modes.

Press  $\nabla$  to reverse the crawler. Increase the speed by holding or pressing  $\nabla$ . Decrease the speed by holding or pressing  $\triangle$ .

In **AUT** mode, the powered drum will automatically retrieve the cable as the crawler reverses. To avoid the risk of jamming the wheels in the cable, the crawler will reverse at a slower speed than the cable.

In **MAN** mode however, the drum will not retrieve the cable and you must synchronize the speed of the crawler and the cable.

To rewind the cable in manual mode, hold the **Fn** key and press  $\nabla$  on the keypad. Hold this key combination to accelerate the rewind speed.

Decrease the speed by holding or pressing **Fn** +  $\triangle$ .

The system will stop reversing when the Auto Stop limit (if set) and the zero point has been reached.

**⚠ CAUTION!** In manual mode, make sure the cable is retrieved faster than the crawler speed. This will help to avoid the risk of jamming the cable in the crawler wheels.



## Manual retrieval with the crank handle

If necessary, you can retrieve the crawler using the crank handle to manually wind the cable back into the drum.

Refer to the Operational Manual for more information.

## 5.7 Steering (P356 crawler only)

**NOTE: Steering the P356 crawler is identical for both the powered and manual system.**

You can steer the P356 crawler left and right, allowing you to navigate pipes with ease. The crawler steers by changing the speed on the left or right motor.



You can steer the crawler when it is moving forwards, backwards or when it is stationary. Steering whilst reversing is possible in manual driving mode only.

**Note: Steering whilst moving is proportional to the crawler speed: the faster the crawler moves the bigger the steer.**

When the crawler is stationary, it will turn on its own axis. Be careful when turning in this fashion as the crawler may become entangled in the cable.

To steer right, press . Hold the key to turn faster.

To steer left, press . Hold the key to turn faster.

You can stop the crawler steering at any time by pressing  if stationary or moving forward or  when reversing in manual mode. If the crawler is moving it will stop steering and continue to move in the same direction.



To stop turning the crawler when it is stationary you can also press  or the spacebar.

## Section 6 – Video and images

### 6.1 Recording video

The P350 features digital video recording, that captures video from the camera and stores it as an MPEG4 video file on the memory card.

You can start and stop a video at any time using the video controls on the keypad.

To create a quick video survey: press the  Video recording button (bottom left under the display). Fill in any survey information (can be left blank) and press  a 2nd time to start recording (notice the recording icon now displays on the screen).

To create a full JOB, navigate to the JOB Browser menu and create a new JOB. Fill in all the relevant CLIENT, SITE and SURVEY information and START the JOB (see the full Operation Manual for further details). This will allow a professional looking survey report to be created quickly in FlexiSight Manager partnered with Microsoft Word.

If necessary, press F10 on the keyboard to zero the counter at the beginning of the survey.

Press  to stop the recording.

For more information about video recording, please refer to the Operation Manual.

### 6.2 Audio commentary

You can easily add audio commentary to your videos. To record commentary, simply attach the optional headset to the connection socket in the command module's I/O panel (Item 12). Start recording and speak into the microphone.

### 6.3 Capturing pictures

You can capture still pictures at any time, during operation, including when you are recording or playing video files. Captured pictures are stored as JPEG files on the memory card.

To take a picture, press  at any time.

## Section 7 – Text and reports

The P350 allows you to add text pages, for instance to add contact, site or survey information on to recorded video. These pages can be saved and repeatedly used for common details.

The P350 features an integrated report writer that allows you to document your survey with text and pictures. Reports can be created in Microsoft Word when used with our companion software, FlexiSight Manager. This includes industry standard WRC and PACP codes widely used worldwide.

Press the  to display text pages which appear overlaid on the video during the intro. Press F1 (EDIT) to edit your text, and press TITLE to turn the page on/off – this sets the text page to display during the video intro. It will display TITLE ON when the page is activated.

Alternatively, to write text on the video quickly at any moment, press the PG UP or PG DN buttons on the keyboard, type the required text and press ENTER or OK to overlay it on the video (ensure the red video recording symbol re-appears!).

For more information, please refer to the Operation Manual.

## Section 8 – Connectivity

### 8.1 USB

You can connect the command module to your PC using the supplied USB cable to transfer video files.

For more information, please refer to the Operation Manual.

### 8.2 Bluetooth®\*

The P350 features an integrated Bluetooth module that allows you to send small files to any compatible device. Bluetooth has limited bandwidth so it's not recommended for sending video files.

Several devices do not currently support the OBEX Bluetooth functionality for file transfer, including most Apple and Motorola phones. A full list is not known due to dynamic industry changes.

For more information, please refer to the Operation Manual.

\*The Bluetooth word mark and logos are owned by the Bluetooth SIG, Inc. and any use of such mark by Radiodetection is under licence.

## Section 9 – System shortcuts

This P350 command module offers a series of keypad and keyboard shortcuts. Familiarizing yourself with the shortcuts will allow you to work more efficiently.

You can access a list of available shortcuts by pressing **Fn + F2** on the keypad or **SHIFT + F2** on the keyboard.

#### Miscellaneous commands and shortcuts

Keypad key		Keyboard key		Description
Fn +	F1	Shift +	F1	Help
Fn +	F2	Shift +	F2	List all shortcuts
Fn +	F4	Shift +	F4	Software versions screen
Fn +	F5	Shift +	F5	Sonde on/off
Fn +	F6	Shift +	F6	Jump to top menu (when possible)
			F9	Enter counter value
	△▽		F10	Calibrate / zero counter
			H	Switch Mimic on / off
Fn +	△	Ctrl +	↑	Decrease drum rate of pull (manual mode only)
Fn +	▽	Ctrl +	↓	Increase drum rate of pull (manual mode only)

#### Crawler commands and shortcuts

Keypad key		Keyboard key		Description
	△		↑	Drive forward
	▽		↓	Drive backward
	◀		←	Steer left (P356 crawler only)
	▶		→	Steer right (P356 crawler only)
	⊙	Ctrl +	C	Motion Stop
		Alt +	←	Lock steer left
		Alt +	→	Lock steer right
		Ctrl +	←	Trim left
		Ctrl +	→	Trim right
			M	Switch drive mode (MAN / AUTO)
			Space-bar	Motion Stop (Drive mode only)

Keypad key	Keyboard key	Description
	F7	Light -
	F8	Light +
Ctrl +	B	Iris close
Ctrl +	D	Light switch
Ctrl +	F	Pan reset
Ctrl +	G	Pan right
Ctrl +	H	Pan left
Ctrl +	I	Rotate clockwise
Ctrl +	J	Zoom reset
Ctrl +	K	Zoom out
Ctrl +	L	Zoom in
Ctrl +	N	Iris open
Ctrl +	O	Rotate anti-clockwise
Ctrl +	T	Focus in
Ctrl +	U	Rotate reset
Ctrl +	Y	Focus out
	W	Target UP
	A	Target Left
	X	Target Down
	D	Target Right
	S	Go to Target
	J	PT camera Scan pipe joint

Keypad Key	Keyboard key	Description
	Ctrl + A	Play
	Ctrl + Q	Take snapshot
	Ctrl + S	Pause
	Ctrl + W	Text
	Ctrl + X	Video stop
	Ctrl + Z	Record

## Section 10 – Care and maintenance

**⚠ WARNING! Clean and sanitize the P350 flexitrax system at regular intervals to help prevent the risk of biological contaminations from foul water sources.**

Do not dismantle component parts, unless directed by the Operation Manual.

Only use Pearpoint supplied parts, warranty and safety will be void if modifications are performed.

### 10.1 Terminals

**⚠ CAUTION! Do not use damaged, dirty or corroded components, including all terminal connections, cables and O-rings.**

Ensure that all terminals and connection points are clean and free of corrosion and debris before you attempt to use this equipment.

Check that any O-rings are clean, greased and not damaged. Use a silicon based grease such as "Super Lube".

Pearpoint recommends protecting all terminals with plastic protection caps when the system is not in use.

If possible, only assemble or disassemble system components in a dry and clean environment.

## 10.2 Cleaning the system

**⚠ WARNING!** Foul water systems can be a source of biological hazards; ensure you clean all equipment with a suitable disinfectant after use.

**⚠ CAUTION!** Do not use high-pressure hoses to clean this system.

### 10.2.1 Command Module

- Clean the case with mild soapy water.
- Use lint-free cloth to clean the TFT screen.

### 10.2.2 Camera, Crawler, Elevator and Lighthouse

- Clean by washing with water and a disinfectant as required.
- Clean the lens with a lint-free cloth.

### 10.2.3 Cable and Drum

- Use a cloth moistened with a suitable disinfectant.

## 10.3 Storing the system

The P350 flexitrac is a precision system. Always store the system, including all components and accessories in clean and dry environment.

## 10.4 Gamepad Control

Below is a diagram of the Gamepad controller buttons. The Gamepad is connected to the same Controller I/O socket as the USB memory drive – only one of these options can be plugged in at any one time. We typically recommend Compact Flash cards are used for video storage.

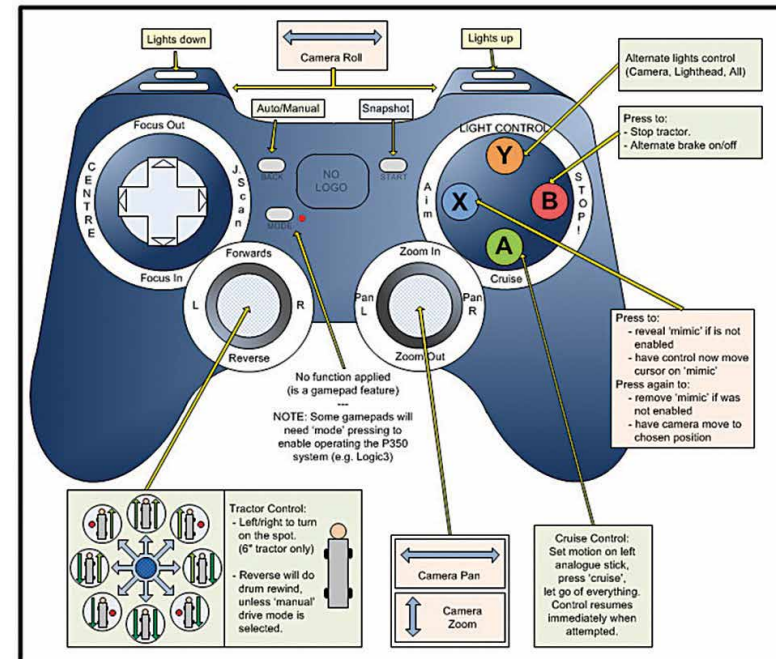

# Global locations

## USA

**SPX Global Headquarters** 13515 Ballantyne Corporate Place, Charlotte, NC 28277, USA

Tel: +1 704 752 4400 [www.spx.com](http://www.spx.com)

**Radiodetection** 28 Tower Road, Raymond, Maine 04071, USA

Tel: +1 (207) 655 8525 Toll Free: +1 (877) 247 3797 Fax: +1 (207) 655 8535

[rd.sales.us@spx.com](mailto:rd.sales.us@spx.com) [www.radiodetection.com](http://www.radiodetection.com)

**Pearpoint** 39-740 Garand Lane, Unit B, Palm Desert, CA 92211, USA

Tel: +1 800 688 8094 Tel: +1 760 343 7350 Fax: +1 760 343 7351

[pearpoint.sales.us@spx.com](mailto:pearpoint.sales.us@spx.com) [www.radiodetection.com](http://www.radiodetection.com)

**Radiodetection (Canada)** 344 Edgeley Boulevard, Unit 34, Concord, Ontario L4K 4B7, Canada

Tel: +1 (905) 660 9995 Toll Free: +1 (800) 665 7953 Fax: +1 (905) 660 9579

[rd.sales.ca@spx.com](mailto:rd.sales.ca@spx.com) [www.radiodetection.com](http://www.radiodetection.com)

## EUROPE

**Radiodetection Ltd. (UK)** Western Drive, Bristol BS14 0AF, UK

Tel: +44 (0) 117 976 7776 Fax: +44 (0) 117 976 7775

[rd.sales.uk@spx.com](mailto:rd.sales.uk@spx.com) [www.radiodetection.com](http://www.radiodetection.com)

**Radiodetection (France)** 13 Grande Rue, 76220, Neuf Marché, France

Tel: +33 (0) 2 32 89 93 60 Fax: +33 (0) 2 35 90 95 58 [rd.sales.fr@spx.com](mailto:rd.sales.fr@spx.com)

<http://fr.radiodetection.com>

**Radiodetection (Benelux)** Industriestraat 11, 7041 GD 's-Heerenberg, Netherlands

Tel: +31 (0) 314 66 47 00 Fax: +31 (0) 314 66 41 30

[rd.sales.nl@spx.com](mailto:rd.sales.nl@spx.com) <http://nl.radiodetection.com>

**Radiodetection (Germany)**

Groendahlscher Weg 118, 46446 Emmerich am Rhein, Germany

Tel: +49 (0) 28 51 92 37 20 Fax: +49 (0) 28 51 92 37 520

[rd.sales.de@spx.com](mailto:rd.sales.de@spx.com) <http://de.radiodetection.com>

## ASIA-PACIFIC

**Radiodetection (Asia-Pacific)** Room 708, CC Wu Building, 302-308 Hennessy Road, Wan Chai

Hong Kong SAR, China

Tel: +852 2110 8160 Fax: +852 2110 9681 [rd.sales.asiapacific@spx.com](mailto:rd.sales.asiapacific@spx.com) [www.radiodetection.com](http://www.radiodetection.com)

**Radiodetection (China)** Room 5-10, Workshop 4, No. 10 Zhenggezhuang Village Beiqijia Town,

Changping District, Beijing 102209, China

Tel: +86 (0) 10 8178 5652 Fax: +86 (0) 10 81785662

[rd.service.cn@spx.com](mailto:rd.service.cn@spx.com) <http://cn.radiodetection.com>

**Radiodetection (Australia)** Unit H1, 101 Rookwood Road, Yagoona NSW 2199, Australia

Tel: +61 (0) 2 9707 3222 Fax: +61 (0) 2 9707 3788

[rd.sales.au@spx.com](mailto:rd.sales.au@spx.com) [www.radiodetection.com](http://www.radiodetection.com)

© 2014 Radiodetection Ltd. All rights reserved. Radiodetection is a subsidiary of SPX Corporation. SPX, the green ">" and "X" are trademarks of SPX Corporation, Inc. Radiodetection, Pearpoint, flexitrx, flexiprobe, FlexiSight and RD7000 are either trademarks of Radiodetection in the United States and/or other countries. Due to a policy of continued development, we reserve the right to alter or amend any published specification without notice. This document may not be copied, reproduced, transmitted, modified or used, in whole or in part, without the prior written consent of Radiodetection Ltd.